



Elektra

ZAKŁADY ELEKTROMECHANICZNE S.I.

ul. Przasnyska 6A

01-756 Warszawa

Tel.(0-22) 4316-171(172) Fax. (0-22) 639 73 45

www.zeelektra.com.pl

email: handel@zeelektra.com.pl

We have implemented ISO 9001

GENERATOR
OF ACOUSTIC WARNING SIGNALS
GES 110/200W

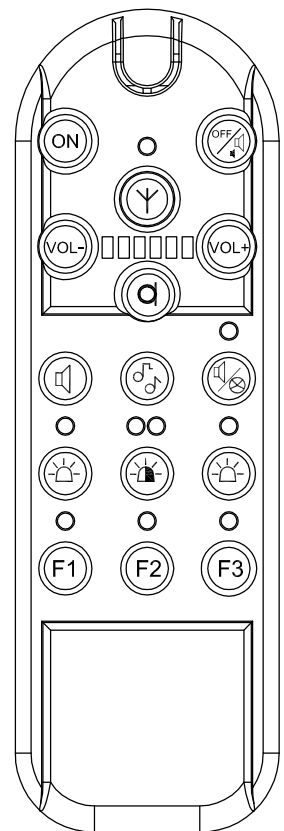

All products of ZE "ELEKTRA" perform the highest requirements in the scope of the total quality.

As a result of the certificate proceedings led by the independent certificate organisation for "ELEKTRA" firm as a producer, has been issued the Certificate affirming that the all products, with reference to the design - technological process, applied materials, production, assembly, technical documentation and service of the customer, performing requirements of the Quality Management System Standards: ISO - 9001- 2009.

INSTRUCTION FOR INSTALLATION AND USE OF GENERATOR OF ACOUSTIC WARNING SIGNALS GES 110/200W

1. GENERAL DESCRIPTION

GES 110/200W generator/controller is the advanced technically unit designed for use in emergency vehicles and fulfilling functions like the multiple siren tone generator, the microphone amplifier and the warning light controller. The device creates the three kinds of the acoustic signals of the different characteristics and enables the changes all the basic signals during the automatic cycle. The unit consists of the three separately modules, the executive power module, power module and control module (manipulator). Inside of control panel is built-in microphone which enables of the emission of the acoustic oral messages in any time of the generator operation. The unit is equipped with the input permitting to the emission an acoustic signals from the other external sources for example from the on-board radio station. The unit allow to control seven devices for example the warning lamp lights equipped with any types of the light source, the led inscription displays, light waves or additional working lights.

2. GENERAL DESCRIPTION OF DESIGN AND SERVICE

The execution module is connected with the control module (manipulator) by the coiled cord and the lengthening cable through the phone connectors. The modules possess the grips enabling the fixing them to the car body.

Dimensions of the modules and the fastening shows Draw. 1. All operation functions of the GES-110/200W unit are accessible by the keyboard of the manipulator according to the description Draw. 2.

3. ASSEMBLY INSTRUCTION

Fix GES-110/200W execution module with use the grips, paying attention to its proper location enabling free flow of air through the ventilation holes of the casing ensuring good cooling and protect the device against the water, moisture and dust. The control manipulator fix in the convenient place for the operator on the dashboard of the vehicle with use a grip. Make the electrical assembly according to the electrical connection diagram, Draw. 1 ;1a and the diagram of the connector connections. Wires should be led carefully without the tensions to protect them from a mechanical damage, the shortest way as possible, and taking into consideration possible repairs of the unit. The unit works with the two loudspeakers each 100 W impedance 8Ω.

Loudspeakers not being in the equipment of the warning light bar should be assembled from the front side of the vehicle into such way that their acoustic tube outputs (emitting voice) was not covered with any parts of the car construction. In the another case can take place a significant reducing of the required level of the acoustic pressure, which shall equals 100 , 115 dB from 7 m. distance.

TECHNICAL PARAMETERS:		□	□
Supply power version		12V	24V
Executive power module	(dimension in mm.)	167 x 60 x 138	167 x 60 138
Power module	(dimension in mm)	167 x 60 x 138	167 x 60 138
Control manipulator	(dimension in mm.)	50 x150 x 25	50 x150 x 25
Supply voltage		10 ÷ 15 V DC	20 ÷ 30 V DC
Current consumption of each power module	Vigil	< 0,08 A	< 0,08 A
	Max	10 A	6 A
Output loudspeaker vottage at rated power of 100W	Loudspeaker 8 Ω/100W	50 Vpp	50 Vpp
Operating temperature range (°C)		-20° ÷ + 50°	-20° ÷ + 50°
Weight (kg)	Executive power module	1,61	1,61
	Power module	1,61	1,61
	Manipulator	0,25	0,25

GENERATOR OF ACOUSTIC WARNING SIGNALS

Demonstrative drawing and dimensions modules

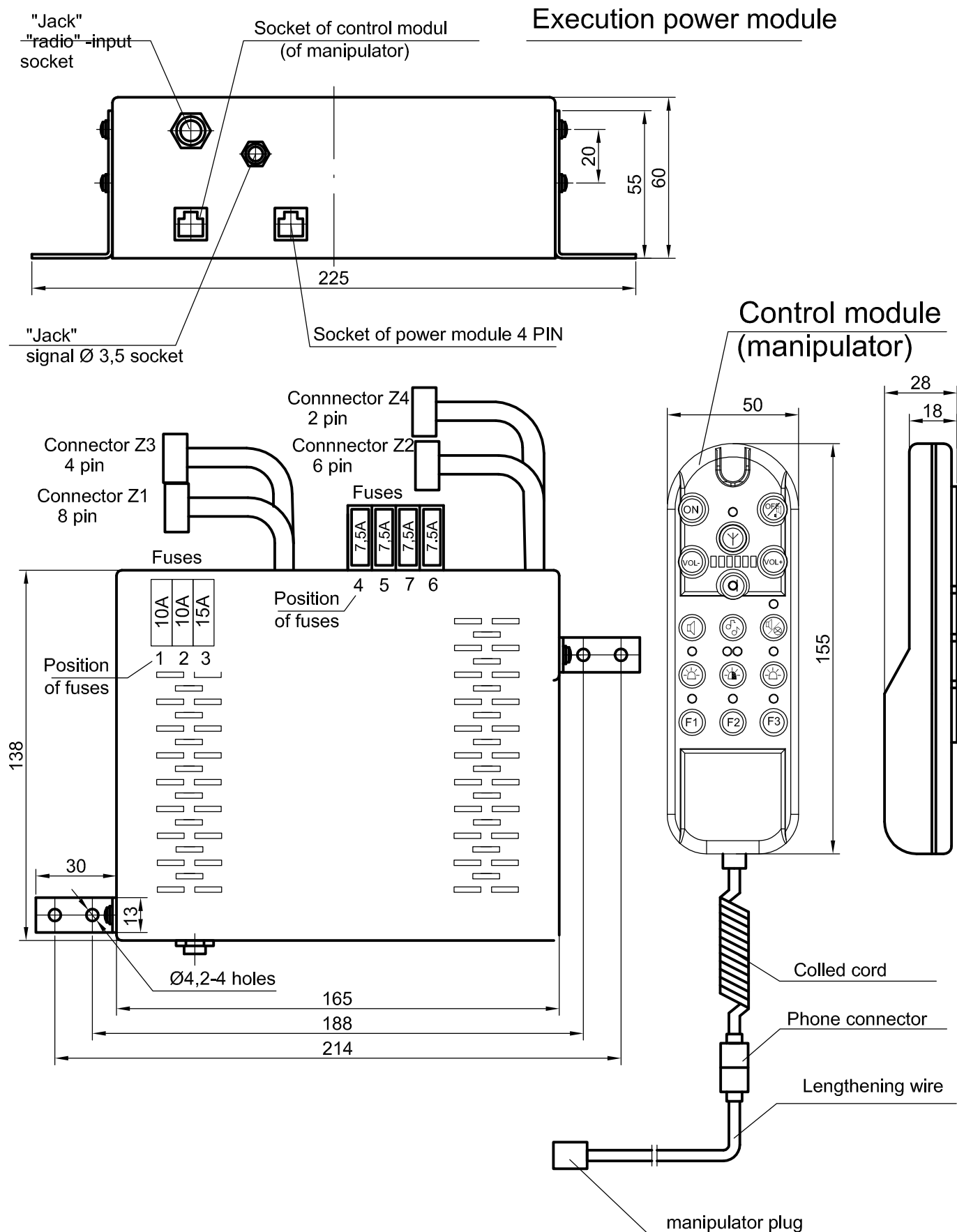

Draw. 1

GENERATOR OF ACOUSTIC WARNING SIGNALS

Demonstrative drawing and dimensions power module

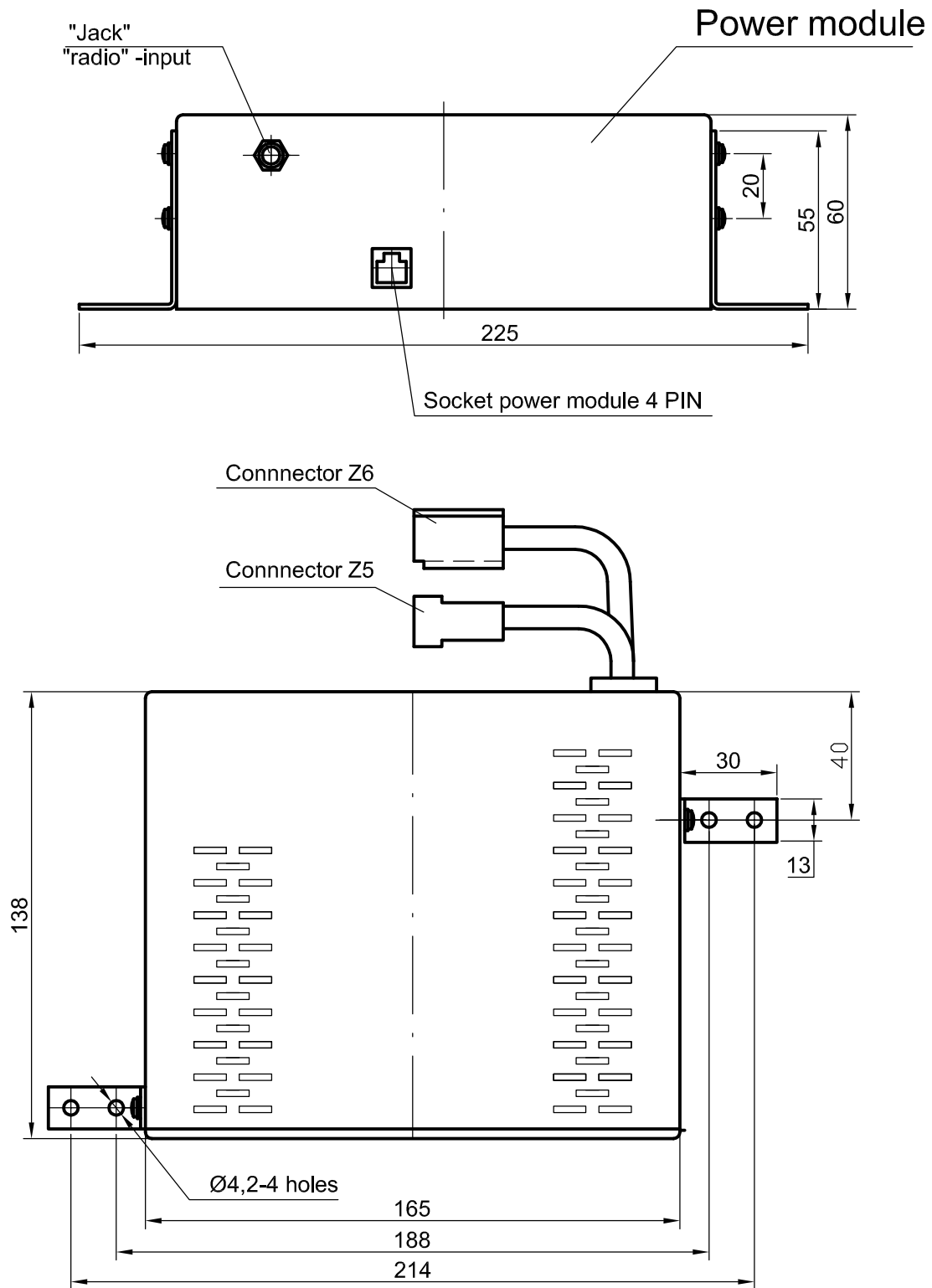

Draw. 1a

CONTROL MANIPULATOR OF GES 110/200W GENERATOR

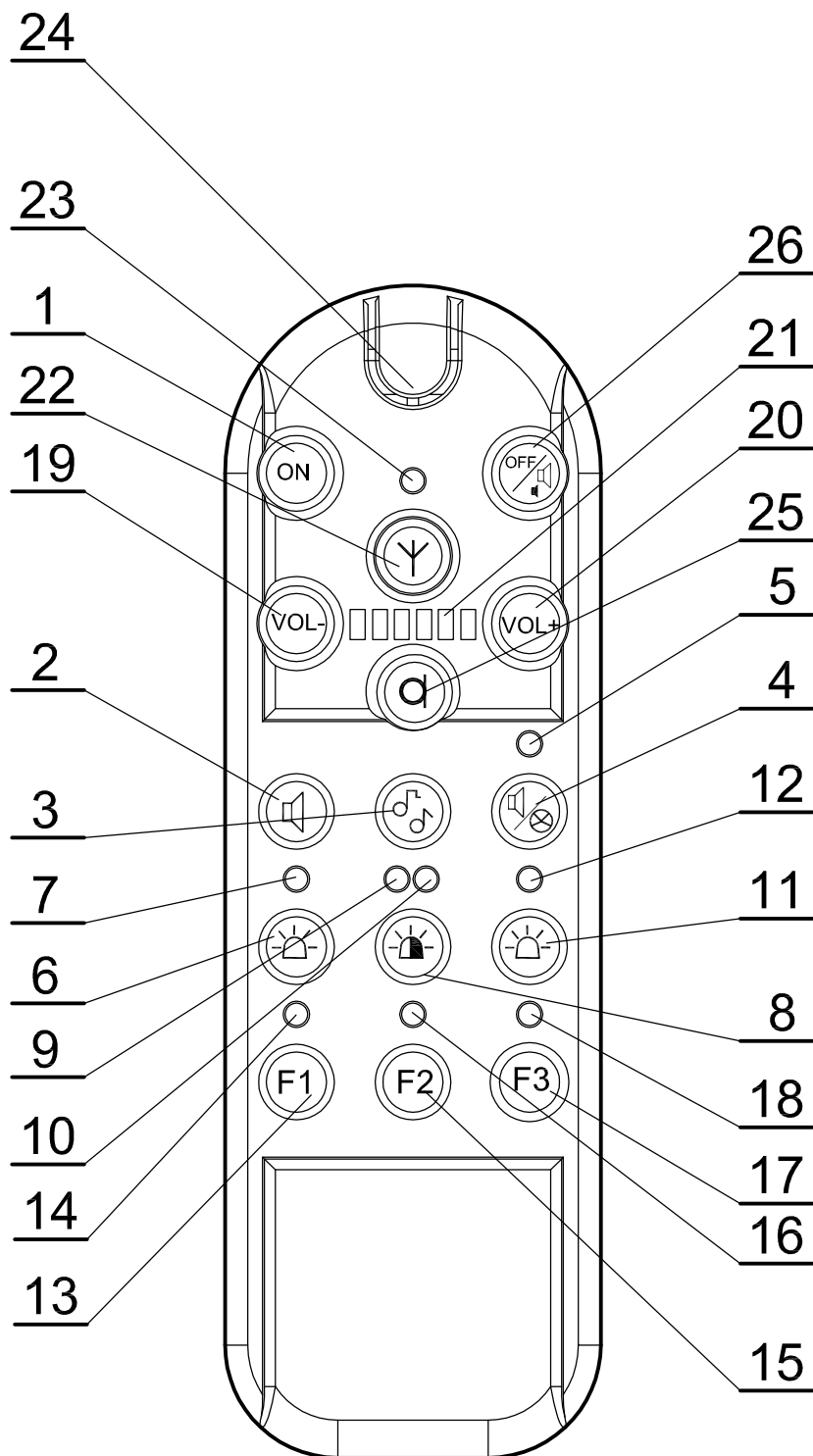

Draw. 2

KEY FUNCTION DESCRIPTION

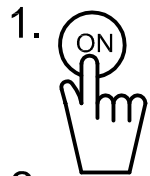

The button "on" - switch on the awakening of the generator
The buttons became underlighted.
Intensity of the light is controlled using buttons 19 and 20
and displayed on the led display 21

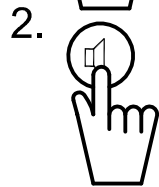

The left button of the voice section.
The short pressing switches-on a voice and all blue warning lamps.
The next short pressing switches-off a voice but the warning lamps still
work.

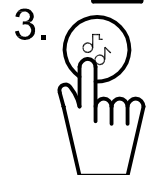

Middle button of the voice section.
The next pressings switch-on HE-LO; WAIL; YELP voice signals in succession.

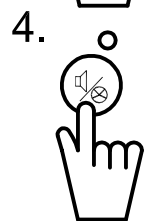

Right button of the voice section (with LED 5).
The short pressing switch-on the HORN voice.
The next short pressing switch-off the HORN.
The length pressing transfers the voice function into the steering wheel of the vehicle,
it is signaled by the illumination of the green LED item 5 (awakening position).
The next short pressings activate voice signals LE-ON,WOLF,YELP,
switch-on of the blue warning lamp.
The next short pressing switch-off the voice signal and the warning lamps.
(return to the awakening position).
The long pressing button 4 activates return to function of voice control using generator, green led
switch-off.

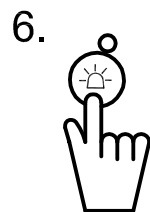

The left button of the warning light section (with LED 7)
The short pressing switch-on all the blue warning lights and the 7;9;12 LED illumination.
The next short pressing switch-off blue lights controled by this button and the illumination of 7 LED.
The long pressing switch off all warning light and the illumination of the 7;9;12 LEDs.

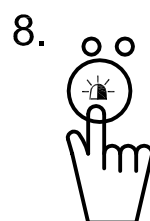

The middle button of warning light section (with 9 i 10 LEDs)
The short pressing switch-on the all blue lamps and the illumination of the 7 ; 9 ; 12 LEDs.
The next pressing switch-on the red lihghts and the illumination of the 10 LED.
(the blue light are working)
The next short pressing switch-off the red lamps and the illumination of the10 LED.
(the blue light are working)
The long pressing switch-off all working lights, (also the red lamps) and the illumination of
the 7; 9; 12 LEDs.

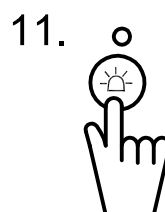

The right button of the warning light seccion (with the 12 LED)
The short pressing switch-on all the blue lights and the illumination of the 7;9;12 LEDs.
The next short pressing switch-of the blue light controled by this button and the
lumination of the 12 LED.
The long pressing switch-off all working lights (also the red lights) and the illumination of
the 7; 9; 12 LEDs.

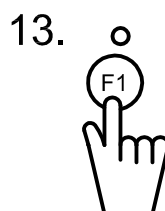

The left button of the additional light section (with 14 LED)

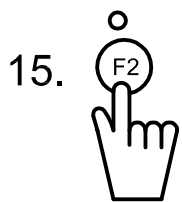

The middle button of the additional light section (with 16 LED)



The right button of the additional light section (with 18 LED)



The button of the control of the microphone and radio amplification level - decrease



The button of the control of the microphone and radio amplification level - increase



The LED display of the amplification level of the microphone and radio.

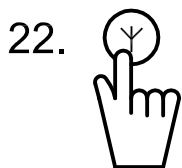

The button "radio" - switch-on of the radio input (with 23 LED)



Microphone

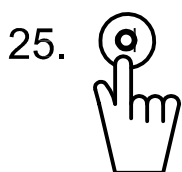

The button of the microphone function.
The short pressing switch-of the warning sound signals and switch-on the microphone or switch-on the microphone directly from the awakening function.
The short pressing activate the return to the previously realised function.

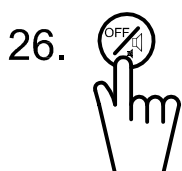

The button "off"/half power
The short pressing reduces of the output power of the generator to half.
The long pressing switch-off the generator and the buton underlighting.

Description of the output terminals of the generator GES 110/200W GES executive power module

1. Supply harness (connector Z4)

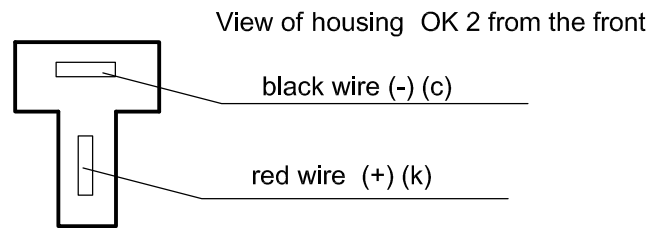

2. Supply harness of seven output channels of generator controller (connector Z3)

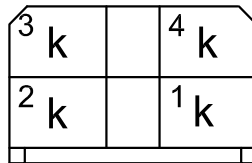

Pins 1,2,3,4 - output channel supply of generator controller (+) - 8 x red wire (k)

3. Control acoustic signal wire harness (connector Z2)

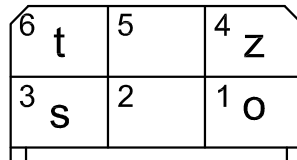

Description of the wire inside of casting :

Pin 1 (-) loudspeaker - brown wire (o)

Pin 3. switch of acoustic vehicle signal (horn) (-)
grey wire (s)

Pin 4 (+) loudspeaker - yellow wire (z)

Pin 6 acoustic vehicle signal (horn) (-) - green wire (t)

4. Control wire harness of lights (connector Z1)

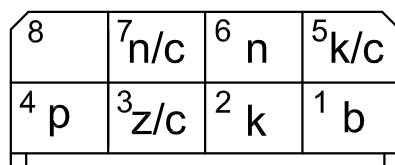

Description of the wire inside of casting :

Pin 1 blue light (right button /11/) - white wire (b), fuse - 10A

Pin 2 blue light (main warning light) (middle button/8/) - red wire (k), fuse - 15A

Pin 3 blue light (left button/6/) - yellow-black wire (z/c), fuse - 10A

Pin 4 red light (middle button/8/) - orange wire (p), fuse - 7,5A

Pin 5 additional light (left button/13/) - red-black (k/c), fuse - 7,5A

Pin 6 additional light (middle button/15/) - blue wire (n), fuse - 7,5A

Pin 7 additional light (right button/17/) - blue-black (n/c), fuse - 7,5A

Pin 8 free

5. Socket type "Jack" Ø 6,3 - "radio" input
6. Socket type "Jack" Ø 3,5 - output of signal power module
7. Telephone socket 6 PIN - input of manipulator wire
8. Telephone socket 4 PIN - control input of the power module

Description of the output terminals of the generator GES 110/200W GES power module

9. Supply harness (złącze Z5)

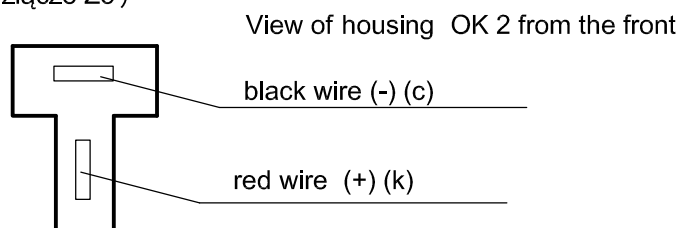

10. Control acoustic signal wire harness (connector Z 6)

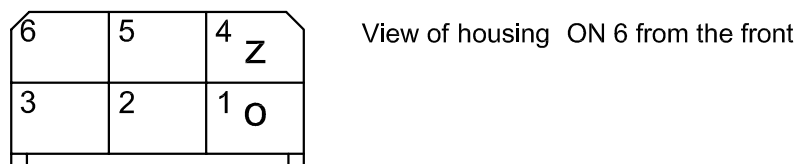

Description of the wire inside of casting :

Pin 1 (-) loudspeaker brown wire (o) Pin 4 (+) loudspeaker - yellow wire (z)

11. Socket type "Jack" Ø 3,5 - input signal executive module

12. Telephone socket 4PIN - input controller executive module

Current protection of the generator GES 110/200W see Draw.1

Fuses in the housing of the generator pos.1-3 (3 pcs)

Pos.1 - Fuse - 10A - protects the output current pin 3 in the connector Z1
(yellow-black wire)

Pos.2 - Fuse - 10A - protects the output current pin 1 in the connector Z1
(white wire)

Pos.3 - Fuse - 15A - protects the output current pin 2 in the connector Z1
(red wire)

Fuses at the rear side of the generator - pos. 4-7 (4 pcs)

Pos.4 - Fuse - 7,5A - protects the output current pin 4
in the connector Z1 (amber wire) -
- controls the red warning light located inside the lightbar

Pos.5 - Fuse - 7,5A - protects the output current pin 5 in the connector Z1
(red-black wire)

Pos.6 - Fuse - 7.5A - protects the output current pin 6 in the connector Z1
(blue wire)

Pos.7 - Fuse - 7,5A - protects the output current pin 7 in the connector Z1
(blue-black wire)

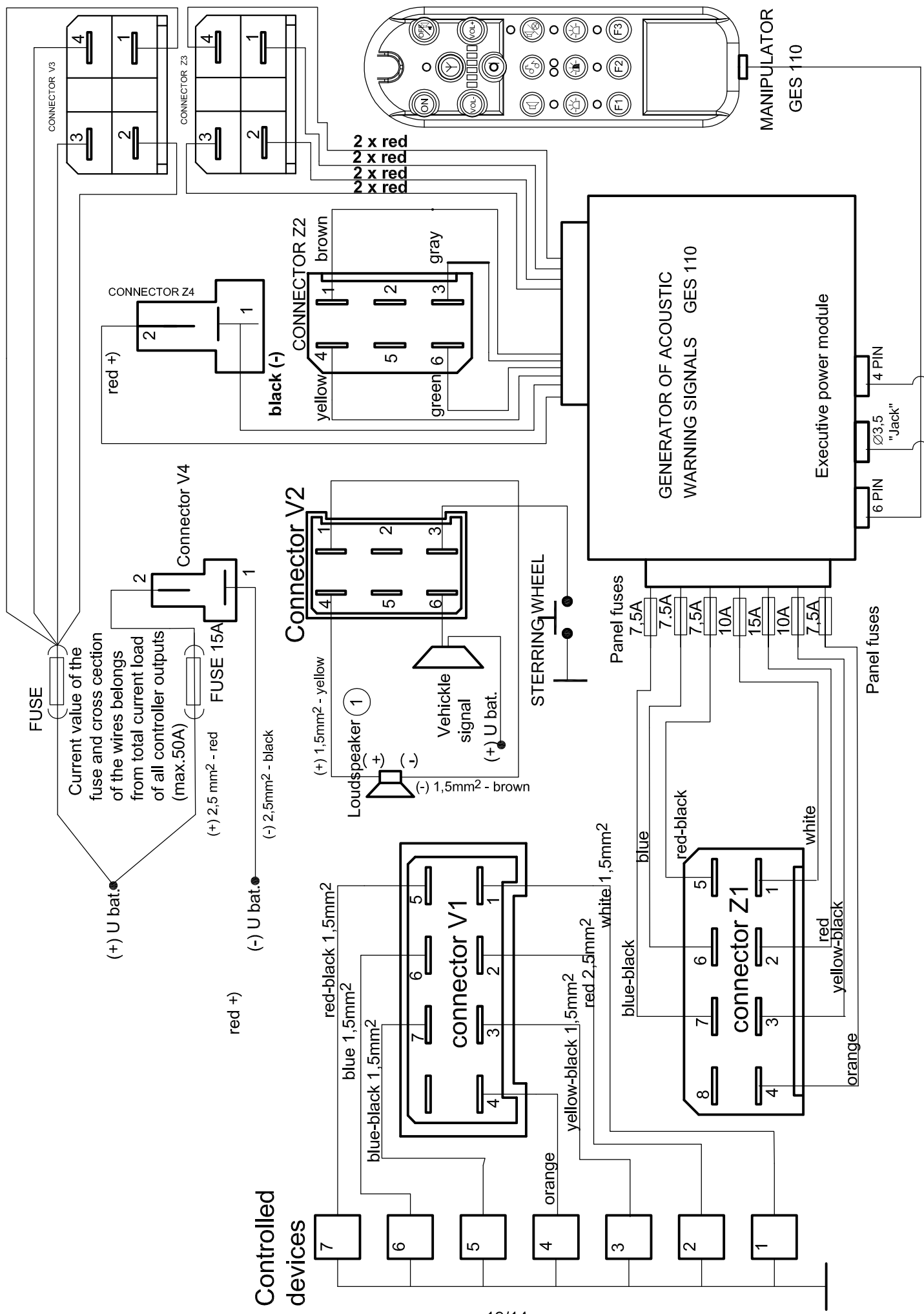

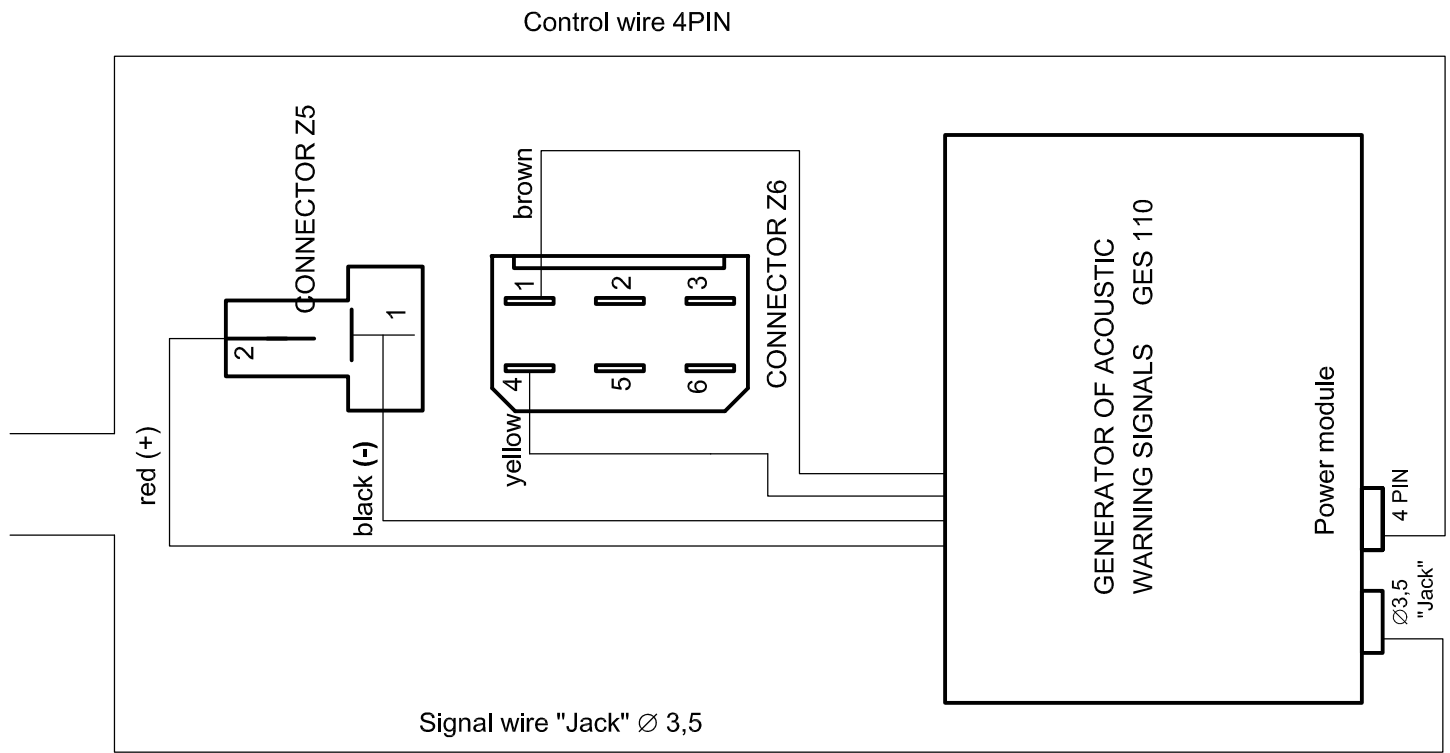
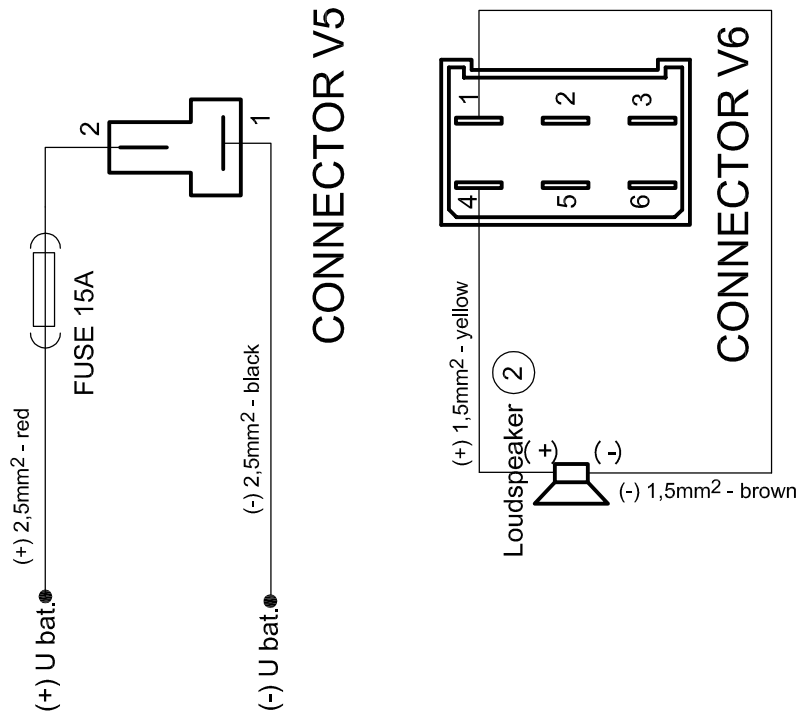

Notes:

1. The device connect directly to the battery terminal.
2. Use only the proper supply voltage which is indicated on the rated plate of the device.
3. In case of suspension of an electronic system (keyboard inactive), you must restart it by unplugging the cable between the manipulator with a generator for a period of 10-30 sec.
4. The device fix in the places free from high temperatures and moisture.
5. The device install in accordance with the informations contained in this manual.
6. Due to possibility of disturbances in the work of the device install this device far from the magnetic fields.
7. The connecting wires shall be as short as possible and perform requiremets of the PN-/S-76021norm.
8. In standby mode generator consumes 0.08A of current. In case longer disuse of sound signalisation generator should be switch off.

Equipment of GES 110 generator :

Box 1:

Executive power module	- 1pc.
Control module (manipulator)	- 1pc.
Manipulator wire /coiled/	- 1pc.
Lengthening wire	- 1pc.
Wire connectorów	- 1pc.
Manipulator grip with screws	- 1pcs.
Module fixing grip	- 2pc.
Plug "Jack"	- 1pc.
Connector casing with connectors	- 1pc.

BOX 2:

Power module	- 1pc.
Connector casing with connectors	- 1pc.
Module fixing grip	- 1pc.
Signal wire "Jack"	- 1pc.
Control cable 4PIN	-1pc.